

VC-A61P Quick Installation Guide

1. A view of the camera's I/O interface

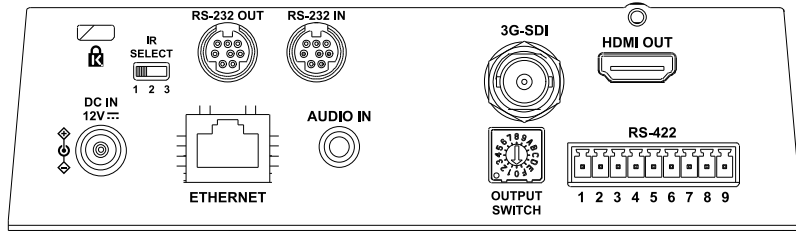

2. Instruction on DIP SWITCH Setting

2.1 OUTPUT SWITCH



The factory setting for the resolution is 1080p/59.94

*SDI supports resolutions up to 1080p 59.94/50

Setting	Output Mode
0	2160p/29.97
1	2160p/25
2	1080p/59.94
3	1080p/50
4	1080p/29.97
5	1080p/25
6	720p/59.94
7	720p/50
8	720p/29.97
9	720p/25
A	1080i/59.94
B	1080i/50
C	Reserved
D	Reserved
E	Reserved
F	Reserved

2.2 IR SELECT

After the IR SELECT is configured, it can be switched from the Camera Select on the remote control

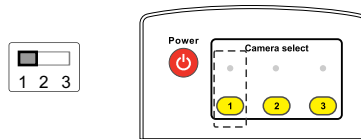

ID	Setting
1	
2	
3	

3. Install the camera on the ceiling

1. Please adjust the resolution on **DIP Switch** prior to installation.
(Please refer to [2. Instruction on DIP SWITCH Setting](#))
2. Fix the metal plate **A** on the machine base with **4 M3** silver screws.

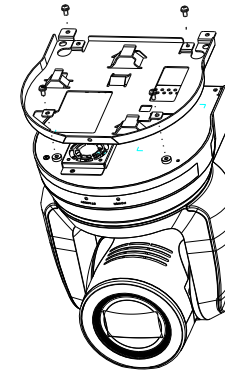

3. Lock the metal plate **B** on ceiling mounted hanger

※**Caution:**

- (1) Please use the hanger that has obtained UL security approval.
- (2) Please reserve the hole for the connecting wires of the camera.

4. Combine the metal plate **A** and the metal plate **B**

▼ Push the metal plate **A** up to the ceiling and then to the right to latch the metal plate **B**.

▼ And then secure with **2 M3** silver screws and **1 M3** black screw.

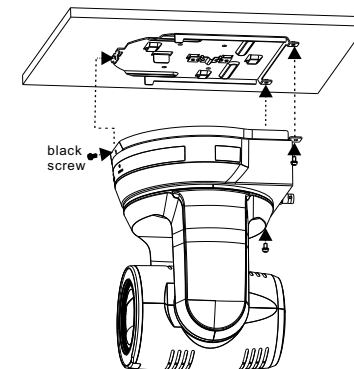

4. About the power supply

- Connect the DC 12 V power adapter for power supply
- Access power by using a router that supports PoE or connecting to a hub with a network cable
- ※ VC-A61P supports PoE+(IEEE802.3at)

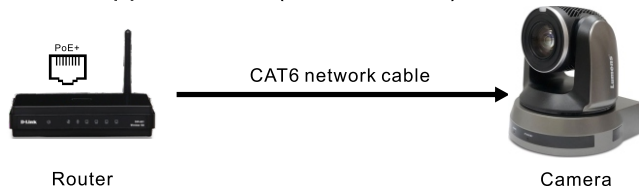

5. Camera connection description

Connect a single or multiple units of VC-A61P, the control keyboard and the computer to the same router; use the control keyboard to control VC-A61P through IP; and use the computer to view the images.

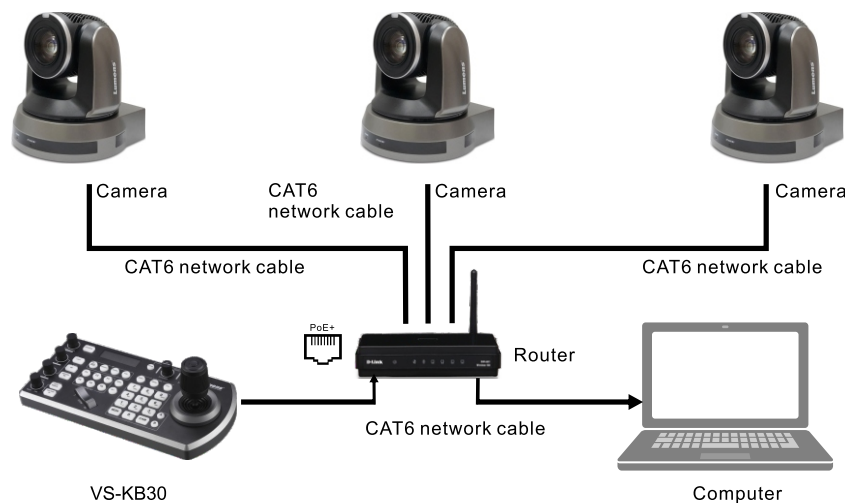

6. View the camera IP image

Open the browser, enter the camera IP address, enter the account and password, and gain access to view the camera IP image and control the camera.

Address

- ※The IP address can be verified by clicking [MENU] => [Ethernet] => [IP Address] on the remote control
- ※If it is not connected to a DHCP router, the default IP address is 192.168.100.100

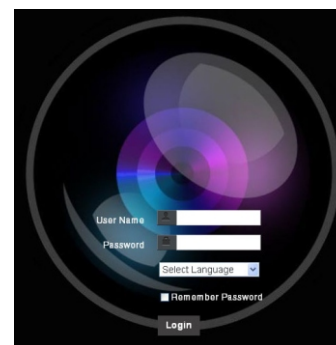

Account: admin
Password: 9999

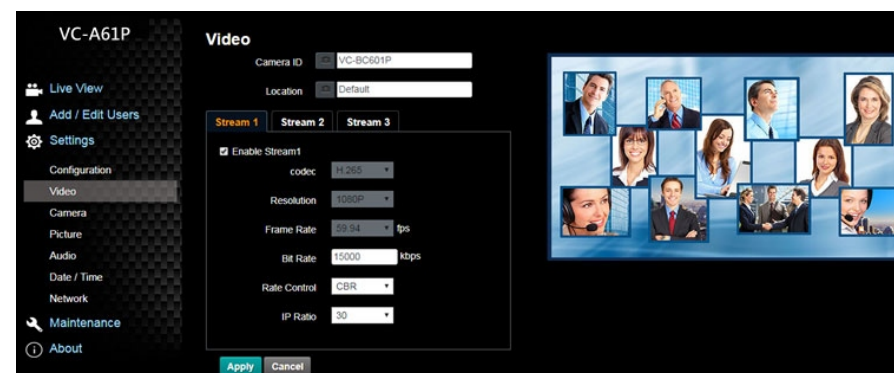

Access is also available by connection through the Lumens VMS software. For details of the operations of Lumens VMS, please download the software and its user manual from the official Lumens website (<http://www.Mylumens.com/support>).